

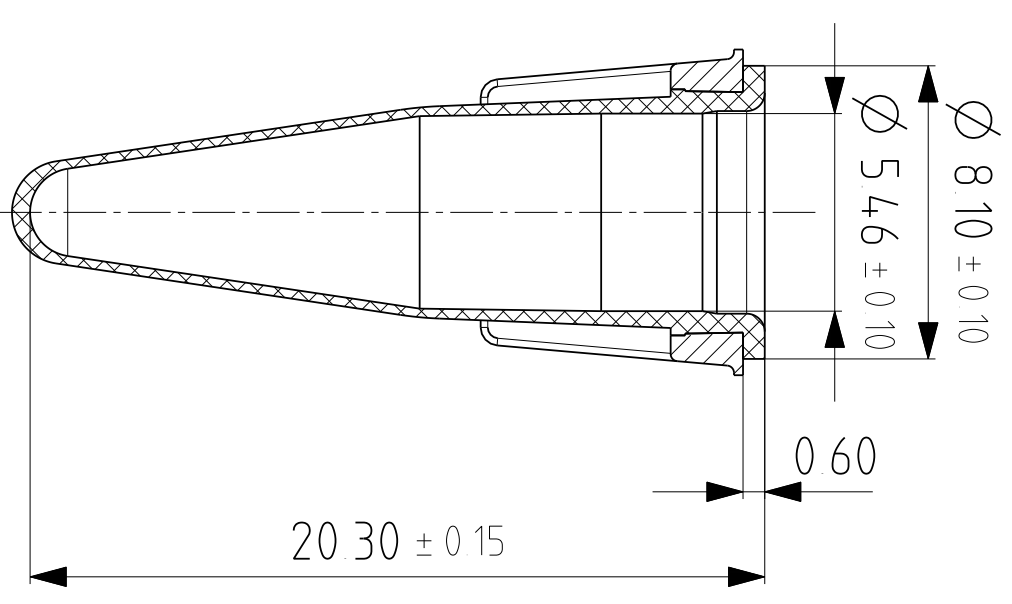

This drawing and/or any technical information relating to it issued in strict confidence and may not be reproduced or used for manufacture without written permission. Upon receipt of which it is the users responsibility to seek confirmation of any dimensions and production tolerances.

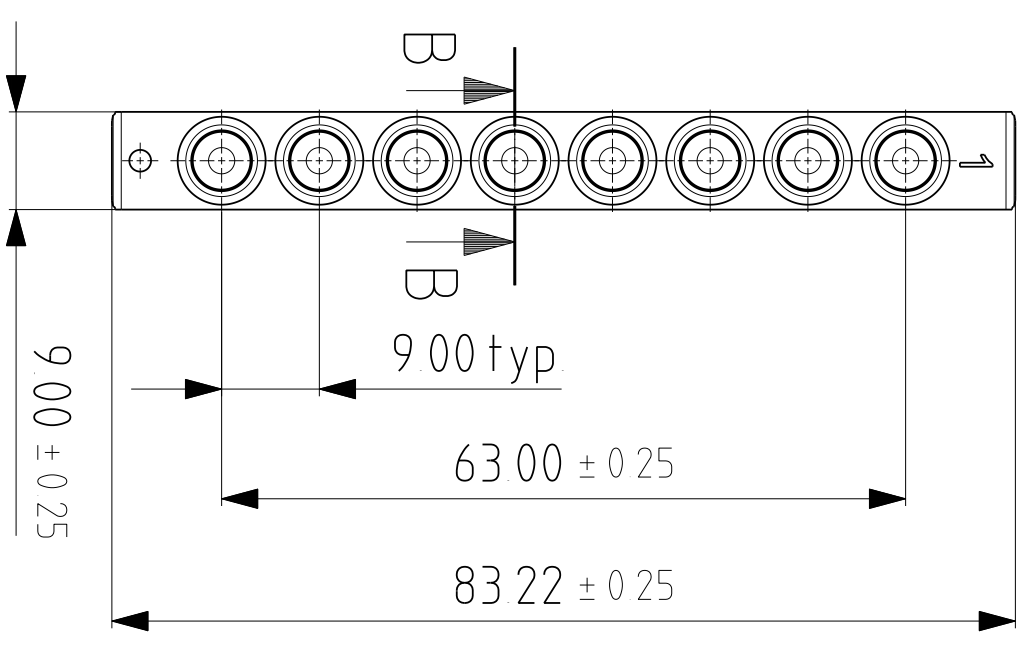
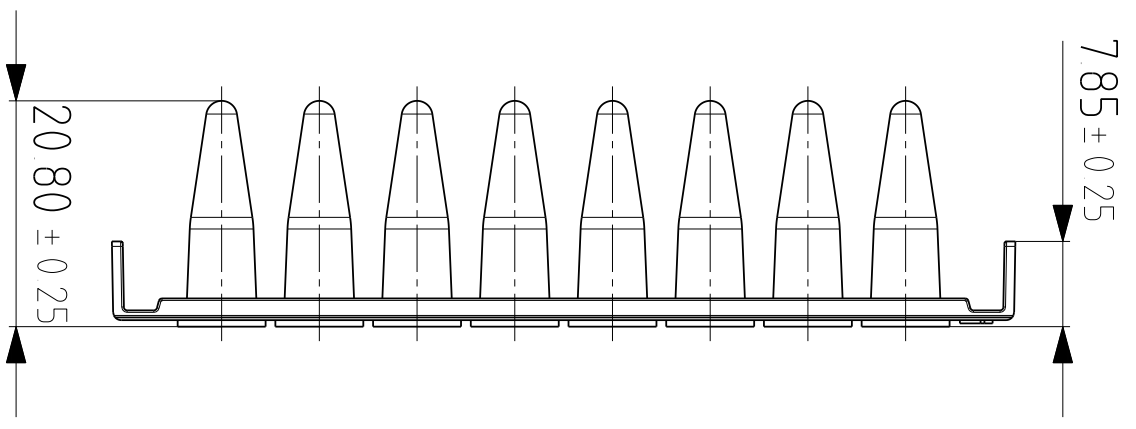
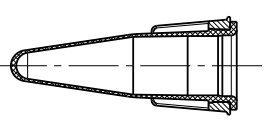

VIAL FORM 8pos.

SECTION B-B

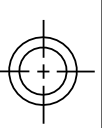
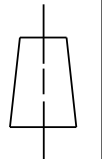

		 		CUSTOMER ZOLTAN E	
DO NOT SCALE		CUSTOMER DRG No.		DATE 16.06.2011	
IF IN DOUBT ASK		MATERIAL		CHECKED PAUL D	
TOLERANCES GENERAL TOLERANCES (UNLESS OTHERWISE STATED)		TOLERANCES ANGULAR		TITLE Individual Framestrip Marketing drawing	
0 ± 0.25 0.0 ± 0.20 0.00 ± 0.10		0 0.0 0.00		DRAWING No.	
(ALL DIMENSIONS IN MILLIMETRES)		SCALE		SHEET No.	
www.azenta.com		ISSUE 1 OF 1		ISSUE 1 OF 1	